

# DESIGN OF DATA COMMUNICATION SYSTEM BETWEEN PROTOTYPE TANK WITH GROUND STATION USING TELEMETRY

Avando Bastari, Endin Tri Hartanto, Arif Wahyudianto, Bagus Irawan

Indonesian Naval Technology College, STTAL  
Bumimoro Morokrembangan, Surabaya, 60178, Indonesia  
arifwahyudianto96@gmail.com

## ABSTRACT

*The Indonesian Navy is one of the elements of the Indonesian nation which has the duty to maintain the unity of the Republic of Indonesia). Military weapons systems that have a protective layer and are armed with firearms . This vehicle can be controlled remotely so that it can be used as a vehicle for land defense that is quite powerful and effective. In realizing a data communication system that is efficient and safe against data breaches, the author tries to raise it into a research theme with the title Research Design of a data communication system between a prototype tank and a ground station use telemetry. In carrying out its function as a means of data transactions between prototype tanks and ground stations that work both ways, telem e try will send data from the prototype tank to the ground station and vice versa telemetry will send data from the ground station to the prototype tank. This is the application of two-way communication. The test results obtained a maximum transmission distance of 60 meters.*

*Keywords : Prototype, Telemetry, Ground station*

## 1. INTRODUCTION

The Indonesian Navy is one of the elements of the Indonesian nation which has the duty to maintain the unity of the Republic of Indonesia. In carrying out the task of maintaining the sovereignty of the nation, the TNI requires many supporting devices, one of which is a supporting tool in carrying out security duties. This support tool is a modern and sophisticated support tool for overcoming difficult problems. Supporting equipment may not be the main equipment in carrying out security duties, but supporting equipment is very useful in providing significant benefits.

In the current era, the development of an increasingly modern era often has an impact that has the potential to present problems that are quite complicated to solve. National stability has become a victim of the development of this era, the problem of borders between countries which often becomes a problem of mutual claims as its territory. Current violations of national borders are difficult to monitor or monitor, Indonesia has many border areas in areas that are difficult to reach, such as border areas in the middle of forests and downstream rivers.

The territory of the Unitary State of the Republic of Indonesia (NKRI), 2/3 of its territory is the sea territory. With a border area with a very wide sea area is one of the problems in

maintaining the sovereignty of the Republic of Indonesia. Currently to get data on national boundaries can be obtained through geospatial intelligence data on national borders. Geospatial intelligence data is data relating to the interests of the state and is intelligence data, these data are related to space on the surface of the earth. Geospatial data obtained from satellite imagery, aerial photographs, radar and others.

Military weapons systems that have a protective layer and are armed with firearms. In general this vehicle is also designed to be able to run on difficult terrain. There are several types of defense equipment that can be distinguished according to their characteristics and role. namely: Main Battle Tanks, armored personnel carriers, infantry combat vehicles, tank destroyers and self-movement artillery. Unmanned is one vehicle that can be used as a vehicle for defense on land without involving personnel in it.

This vehicle can be controlled remotely so that it can be used as a vehicle for land defense that is quite powerful and effective. To be able to control tanks wirelessly generally use a sophisticated and powerful data communication system against interference with data breach attempts. In general, the data sent must be encrypted and protected on a special frequency channel. The main problem

in the data communication system is the data breach, this is the basis as a mandatory requirement for secure data communication in the State defense system.

In realizing a data communication system that is efficient and safe against burglary, the author tries to raise it into a research theme with the title Research Design of a Data Communication System between Prototype tanks and Ground Station Using *Telemetry*.

In accordance with the geographical location of the Republic of Indonesia on the Asian continent, the recommended frequency used in telemetry uses 433Mhz frequency. In carrying out its function as a means of data transactions between prototype tanks and ground stations that work both ways, telemetry will send data from the prototype tank to the ground station and vice versa telemetry will send data from the ground station to the prototype tank.

In this study, it is necessary to formulate problems in the Design of Data Communication System Between Prototype Tank and Ground Station Using Telemetry. Some of these problems are:

- a. How is data communication using telemetry?
- b. How to apply data communication in two directions using *telemetry* ?

The purpose of the design of building a data communication system between prototype tanks and ground stations using telemetry is:

- a. Make data communication using telemetry.
- b. Implement data communication in two directions using telemetry.

The benefits of the design of a data communication system between the prototype tank and Ground Station using telemetry are:

- a. As the application of a wireless data communication system in the Indonesian Armed Forces tank war equipment.
- b. As a means of delivering data through the air that is concise and minimalist in terms of size.
- c. As a basis for the development of wireless data communication technology that is safe and one of the solutions to security solutions in data communication.

## **2. RESEARCH METHOD**

### **2.1 Research design**

Research design The design of a data communication system between a prototype tank and a ground station using telemetry is a series of procedures to translate the analysis

results of a system to a communication system on a UHF network. and make a communication system using telemetry at 915Mhz frequency. In the research design, build a data communication system between the prototype tank and Ground Station using telemetry by applying the stages of research, as follows:

#### a. Preliminary studies

Preliminary studies are study processes to obtain information about the research to be conducted.

#### b. Problem analysis

Problem analysis is a study to find out the causes of problems, as well as alternative solutions and later solutions to problem solving

#### c. Need analysis

Needs analysis aims at perfecting existing needs to ensure stakeholders understand it and find mistakes, omissions, and other deficiencies if any.

#### d. Design analysis

Is the process of selecting tools to analyze data, so that the formulation of the problem can be solved and the objectives can be proven. On this stand the writer must choose a data analysis tool in accordance with the data to be obtained in the field study. In this step the author can determine the tools that can help to determine the design of data communication and the objectives can be realized.

#### e. Design.

Based on a study of design analysis in the previous paper, information can be obtained to carry out the process of designing a data communication system.

## **2.2 Research procedure**

### a. Research Time and Place

The research location is a place or area where the research will be conducted. The research conducted by the author took place on the Moro Krembangan STTAL Campus in Surabaya. The time used in this study began in July 2019 until the end of December 2019.

### b. Research Tools and Materials

Tools and materials needed to support this research process and system implementation.

#### 1) Research Tools

The tools used in the study consisted of hardware and software.

1. Computer hardware and laptop 32/64 bit architecture processor, 4 GB Random Access Memory RAM, Windows 7 Operating system

- 2. Arduino IDE Software 1.8.0
- 2) Research Materials
  - 1. Arduino IDE
  - 2. Laptops

The following Arduino IDE data that need to be known before the process of making a microcontroller program. Arduino IDE Studio is available on Windows, Linux and Mac versions. Minimum system requirements for running Arduino IDE programs. Arduino IDE used version 1.8.0

c. Research Design

The design research and prototype development were carried out in several stages, starting from the design to prototype testing. In Figure 2.1 explains the flow of research activities starting from the design, manufacture and testing of the system, as well as analysis and validation of the system in order to obtain a reliable system and work in accordance with the design and initial purpose of manufacture.

The main points are the testing of each module and device made and the communication protocol test used as mentioned earlier. The final result is a study and analysis to obtain the communication protocol in this study.

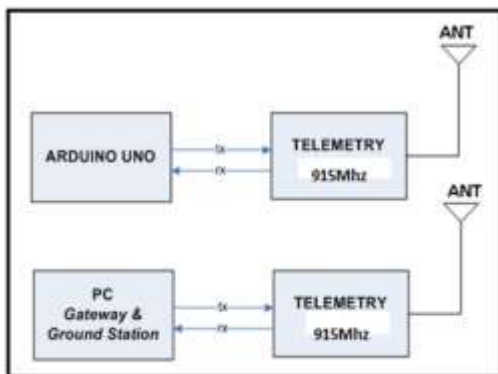

Figure 2.1 Data Communication Block Diagram Design Between Prototype Tank and Ground Station Control

d. Data Collection

In research on the Design of Data Communication Systems between Prototype tanks and Ground Station using telemetry, the authors conducted a study by collecting data. Research data collection methods The design of a data communication system between the prototype tank and the Ground Station uses telemetry which will be carried out by the author, namely:

1. Observation, this method is done by the writer by doing research directly in the field.
2. Interview, this method is done by conducting question and answer to competent parties regarding data communication wirelessly.
3. Documentation, this method is done by collecting data from books, notes, and research results at relevant agencies regarding wireless data communication.

e. Data Processing

Data processing is a process that the writer does after obtaining some information collected in the data collection process. The data obtained will be reviewed and become a reference in the process of design analysis and system design.

f. FSK Communication Design Using HC-12 Module

In designing the data transmission system as a modem using the HC-12 module which has been integrated RF transmission system by applying FSK mulasi. The use of this module in the tank vehicle is connected to the Arduino UART link communication channel, with the baudrate determined at 9600 bps.

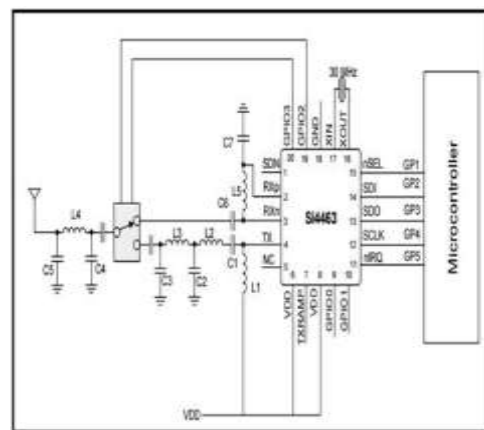

Figure 2.2 FSK HC-12 Modem Series

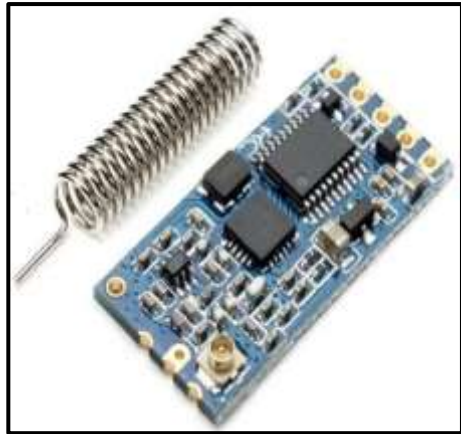

Figure 2.3 Physical Forms of FSK HC-12 Modem

For the telemetry modem to function properly, it must be used with an Arduino device on the correct communication channel. The Tx pin is connected to the Arduino Rx pin, while for the Rx modem pin the Arduino Tx pin is connected. And keep in mind also that this channel is at TLV level 5V so that voltage levels not allowed more than 5Vdc.

The data transmission flow chart is shown in Figure 3.5, the process begins with sensor data retrieval followed by the process of forming data formats and the process of sending data through telemetry. The process of sending data is sent to GCS every 1 second. This is done so that the data can be monitored in real time. Data is formed by inserting the character ',' after each sensor's data. The ',' character as an indicator of the separation process on the GCS side.

On the receiver side, it is explained in the flow diagram of Figure 3.6, which explains the receiving process to the process of separating the data to fit the data format in GCS.

### 2.3 Operational definition

In its operational activities, variables are used in making modules, both dependent, dependent, and free variables have functions including:

- a. KB : is a unit of data capacity in kilos.
- b. Mhz : unit that states the frequency in mega herts.
- c. Bps : unit that states the amount of the width of the communication field in bits per second.
- d. TTL : Time to Live (TTL) is a mechanism that limits the age of data in a computer or network. TTL can be implemented as a counter or timestamp attached or embedded in the

data. After a count of events or time periods have passed, data will be discarded.

e. Data packet : also called a network packet is a basic unit of information that can be transmitted over the network or through digital communication.

## 3. SYSTEM DESIGN, IMPLEMENTATION, AND TESTING

### 3.1 System planning

In this chapter the author will discuss the analysis and discussion of data communication systems between prototype tanks and ground station control through telemetry communication. Telemetry planned in the design sub-section uses UHF channels with a frequency of 915 Mhz. System analysis and discussion of the system planned and made, will discuss the telemetry design to be used, its implementation or application and system testing will be explained in detail.

In designing the data communication system between the prototype tank and ground station control through telemetry communication, the author plans and designs the communication system using 3DR telemetry on the UHF channel with a frequency of 915 Mhz.

The 3DR Radio telemetry system was designed as a radio device that is open source, with a relatively inexpensive price, has a communication distance of up to 1 km and good performance for radio communication.

This system provides full duplex links using HopeRF's HM-TRP module which runs custom, with firmware that is open source. The interface to the telemetry module is done via serial TTL / FTDI USB serial.

Analysis of the system in data communication between prototype tanks and ground station control through telemetry communication, the authors define several variables in the data communication system in relation to the delivery of information. The definition of variables in the communication system between the prototype tank and ground station control is intended so that the information sent can be received and translated as an order as well as information as monitoring data.

The following is the definition of the variable used by the author, in managing the format of data sent from the prototype tank to the ground station control.

- a. GPS Status, in this data format the author determines 1 byte of data as GPS

status information. Status 0 = GPS does not fix, status 1 = GPS fix.

b. Latitude, is latitude information. In this data the author uses the long format which has a capacity of 4 bytes of data.

c. Longitude, is longitude information. In this data format the author uses the long format which has a capacity of 4 bytes of data.

d. Speed, is the prototype tank's speed information. In this data format the author uses the int16 format which has a capacity of 2 bytes of data.

e. HDOP, is GPS accuracy on horizontal lines. In this data format the author uses the int16 format which has a capacity of 2 bytes of data.

f. Yaw, is the prototype orientation towards the earth. In this data format the author uses the int16 format which has a capacity of 2 bytes of data.

g. Pitch, is the angle of attitude towards the nodding orientation. In this data format the author uses the int16 format which has a capacity of 2 bytes of data.

h. Roll, is the angle of attitude towards the orientation of the bolster. In this data format the author uses the int16 format which has a capacity of 2 bytes of data.

i. Temp, is the temperature data in a prototype tank device. In this data format the author uses the int16 format which has a capacity of 2 bytes of data.

j. Obstacle, is the distance information of the prototype tank with the object in front of it. In this data format the author uses the int16 format which has a capacity of 2 bytes of data.

k. RPM L, is information on the rotation speed of the left motor rotation of the prototype tank device. In this data format the author uses the int16 format which has a capacity of 2 bytes of data.

l. RPM R, is information on the rotation speed of the right motor rotation of the prototype tank device. In this data format the author uses the int16 format which has a capacity of 2 bytes of data.

m. AVG\_V, is the battery voltage information. In this data format the author

uses the int16 format which has a capacity of 2 bytes of data.

n. AVG\_I, is the current information that is driven by the battery. In this data format the author uses the int16 format which has a capacity of 2 bytes of data.

o. NUM OF SATELLITES, is information on the number of satellites received by GPS devices. In this data format the author uses the int16 format which has a capacity of 2 bytes of data.

In designing the format of data sent periodically to GCS, in each data the author inserts the character ',' as the separating character of each data. If compiled it will form the following data format.

```
# gps_status, lat, lng, speed, hdop, yaw, pitch, roll, temp, obst, rpml, rprr, avg_v, avg_i, satellite + '\r\n'
```

If calculated the total capacity of bytes required for data transmission

$$\begin{aligned} \text{Total bytes} &= 1 + 1 + 1 + 4 + 1 + 4 + 1 + 2 \\ &+ 1 + 2 + 1 + 2 + 1 + 2 + 1 + 2 + 1 + 2 + 1 + 2 + \\ &1 + 2 + 1 + 2 + 1 + 2 + 1 + 1 + 2 + 1 \end{aligned}$$

Total bytes = 47 bytes

Total bits = 47 x 8

= 376 bits

With a total data transmission capacity of 376 bits, the baudrate for UART communication between a microcontroller and a telemetry device of 9600 bps is sufficient. On the GCS side the authors parse the data to separate each data according to its purpose. Parse process is a process to separate data with certain separator characters.

Because the sender uses the ',' character to separate data, the recipient side must also use the ',' character to divide the data. The parse function in C # programming, the author uses the 'Split' function. The split function is used to separate characters based on the separator character ',' and will return a string array with as many arrays as separated data.

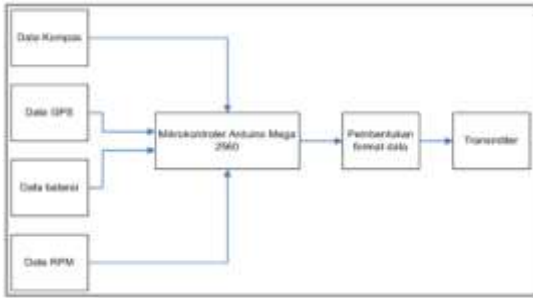

Figure 3.1 Transmitter System Block Diagram

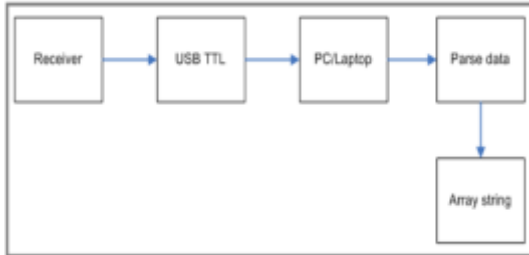

Figure 3.2 Receiver System Block Diagram

### 3.2 Implementation

To implement a data communication system between the prototype tank and ground station control via telemetry, the authors configure telemetry using the Mission Planner program. The steps that need to be carried out are as follows;

- Connect one radio to the computer using a micro USB cable.
- Turn on the radio mounted on the prototype tank
- Open the Mission Planner software
- Enter Initial settings.
- Select hardware options.
- Click the SiK Radio page.
- Set the correct COM port and set the baud rate to 57600.
- Press the load settings button.
- Local and remote areas must be filled with the same values including the firmware version.



Figure 3.3 Radio Telemetry Settings Using Mission Planner

### 3.3 Testing

To test data communication, the authors assemble telemetry on both prototype tank devices and on PCs / laptops. The telemetry on the prototype tank is connected to the Arduino Mega 2560 Serial 1, while the other telemetry is connected to the PC via a USB channel.

In the settings described in the implementation sub-chapter, the baudrate settings on the two sides of the prototype tank and PC / laptop devices must be set at 9600 bps. In the prototype tank, periodically that is 1000 ms will send data to GCS. The data sent (which has been mentioned in the design sub-section) is the monitoring data. For more details, can be seen in Figure 3.4 series of data communication testing.



Figure 3.4 Data Communication Testing series

To get the results of the formation of the planned data format the authors carry out testing locally on the transmitter side. Figure 3.5 follows is the result of forming data on the transmitter side.

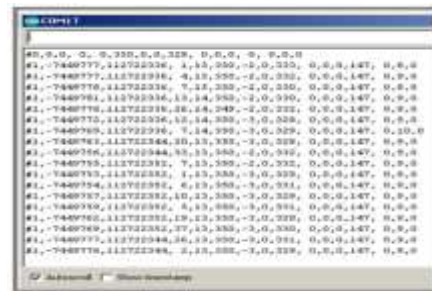

Figure 3.5 Test Results of Communication Through Terminal Monitor

After reviewing that the data generated has been formed correctly, the next testing process is testing data communication with Ground Station Control. This test is conducted to determine whether the data sent has been received correctly.

```

Output
Show output from: Debug
#1,-7449794,112722382,0,04,052,-3,5,329,0,0,0,347,0,0,0
#1,-7449796,112722382,0,04,051,-3,5,329,0,0,0,347,0,0,0
#1,-7449796,112722382,0,04,051,-3,5,329,0,0,0,347,0,0,0
#1,-7449794,112722384,0,03,051,-3,5,329,0,0,0,347,0,0,0
#1,-7449796,112722384,0,04,051,-3,5,329,0,0,0,347,0,0,0
#1,-7449796,112722384,0,04,051,-3,5,329,0,0,0,347,0,0,0
#1,-7449797,112722384,0,04,051,-3,5,329,0,0,0,347,0,0,0
#1,-7449801,112722384,0,04,052,-3,5,329,0,0,0,347,0,0,0
#1,-7449804,112722384,0,03,051,-3,5,329,0,0,0,347,0,0,0
#1,-7449805,112722384,0,03,051,-3,5,329,0,0,0,347,0,0,0
#1,-7449801,112722384,0,04,052,-3,5,329,0,0,0,347,0,0,0
#1,-7449801,112722384,0,03,052,-3,5,329,0,0,0,347,0,0,0
#1,-7449796,112722384,0,03,051,-3,5,329,0,0,0,347,0,0,0
#1,-7449796,112722384,0,03,051,-3,5,329,0,0,0,347,0,0,0
#1,-7449799,112722384,0,03,052,-3,5,329,0,0,0,347,0,0,0
#1,-7449798,112722384,0,03,051,-3,5,329,0,0,0,347,0,0,0
#1,-7449795,112722384,0,03,051,-3,5,329,0,0,0,347,0,0,0
#1,-7449797,112722384,0,03,051,-3,5,329,0,0,0,347,0,0,0

```

Figure 3.6 Results of Data Communication Testing on GCS

Testing by analyzing data communication is the main discussion on this test. The test that will be done by the writer is to analyze the communication with the parameters of distance, delay in receiving and receiving package errors. The testing was done by adjusting the transmission distance from the prototype tank with the GCS. Test distance is carried out until reaching the maximum transmission distance, at the maximum distance it is expected that the data can still be received properly.

At the distance when a signal loss occurs, the writer will be used as the maximum distance transmission parameter. In the next test the writer will test the data communication in line of sight without obstruction. In testing in this way to get the maximum transmission distance without any obstacles or obstacles that can affect data transmission. To do this test the author will connect the telemetry transmission system on a prototype tank device with the GCS system on a laptop device.

Figure 3.7 below is a display of the GCS interface that displays an interface that aims to test data communication.



Figure 3.7 Interface Interface Communication Testing Map

Data communication on a testing distance of 9 meters can be plotted on a graph that has been provided in the GCS application interface, which explains the time interval graph of data transmission and distance plots. On the blue line data graph communication interface describes the time interval line graph and the

orange line graph shows the distance with the value of dividing 100. This test is carried out the plot of distance data and the delivery time interval shown in Figure 3.8 below.

In the communication data plot obtained a fairly stable delivery time interval. This can be seen in the blue line graph which shows time intervals approaching 1000 ms, which indicate that the reception time interval is not different from the time interval for sending data.

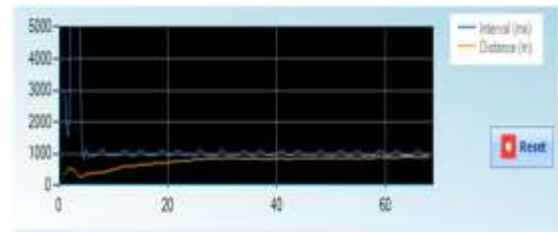

Figure 3.8 Plot Data Communication Chart Distance of 9 meters

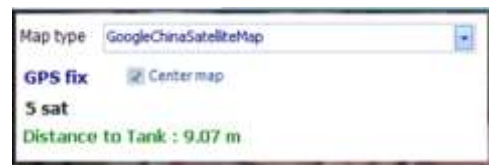

Figure 3.9 Interface Display of GCS Distance with Prototype Tank.

The next test the author changed the distance of the prototype tank with GCS at a distance of 13.44 meters. Test results that prove the distance of the transmission are shown on the map interface display Figure 3.10. In this test the location of the GCS remained as in the previous test, the location of the prototype tank was changed by moving the location of the prototype at a distance of 13.44 meters.



Figure 3.10 Communication Distance Testing Map Interfaces

Data communication at a distance of 13.44 meters In the communication data plot obtained a fairly stable delivery time interval. This can be seen in the blue line graph which shows time intervals approaching 1000 ms, which indicate that the reception time

interval does not differ from the time interval for sending data. This is shown in Figure 3.11. seen in this picture is quite stable at the time of delivery.

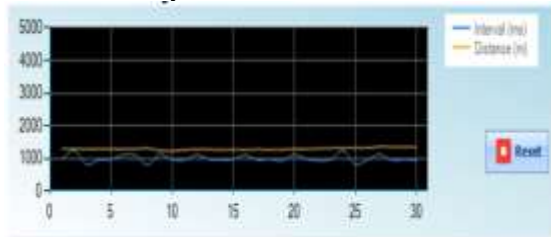

Figure 3.11 Plots of Communication Data Chart for Distance of 13.44 meters

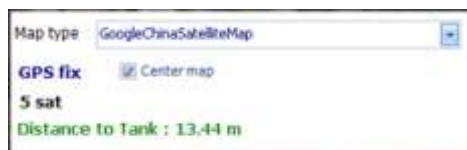

Figure 3.12 GCS Distance Display Interfaces with Prototype Tanks.

The next test the author changed the distance of the prototype tank with GCS at a distance of 20.9 meters. Test results that prove the distance of the transmission are shown on the map interface display Figure 3.13. In this test the location of the GCS remained as in the previous test, the location of the prototype tank was changed by moving the location of the prototype at a distance of 20.9 meters. This test is carried out a plot of distance data and the delivery time interval shown in Figure 3.14 below.

In the communication data plot obtained a fairly stable delivery time interval. This can be seen in the blue line graph which shows time intervals approaching 1000 ms, which indicate that the reception time interval is not different from the time interval for sending data. Thus at a transmission distance of 20.9 meters data communication is said to be going well.



Figure 3. 13 Interface Interface Communication Testing Map



Figure 3.15 Plots of Time Interval Data Acceptance Charts

In the graph Figure 4.15 there was no communication failure so there was no repetition of data transmission. The time interval for receiving data can be said to be stable with a time drift greater or smaller than 1000 ms and no time interval deviation occurs up to double the nominal value.

#### 4. CONCLUSION

The conclusions obtained are based on the design of the data communication system between the prototype tank and the ground station using telemetry that has been made, namely:

- Data communication obtained the maximum results with a communication distance of 60 meters, the test location is done in an open place.
- In a prototype tank data transmission system, obstacles or obstacles can affect the transmission distance. The more obstacles the shorter the distance obtained. Obstacles can affect the data packet received at the receiver. Data packet error found, this is indicated by the loss of a number of bytes of data received. This results in data not being fully received so it is called packet loss.
- In testing the transmission time or delivery delay is obtained until the data is received, the further the delay will be even greater. Obstacles will cause a large delay.

#### ACKNOWLEDGEMENT

The authors greatly acknowledge the support from STTAL Surabaya Indonesia for providing the necessary resources to carry out this research work. The authors are also grateful to the anonymous reviewers and journal editorial board for their many insightful comments, which have significantly improved this article.



## REFERENCES

- Andrianto Heri, 2008, AVR ATMEGA16 Microcontroller Programming, Informatics, Bandung.
- Bejo Agus, 2008, C and AVR Secrets of Ease of Language C in the ATmega8535 Microcontroller, first edition, Graha Ilmu, Yogyakarta.
- Dermanto Trikueni, 2013, The reversal of the direction of the dc motor, <http://trikueni-system-design.blogspot.com/2013/10/Replace-turn-motor-DC-seri.html> accessed on 4 July 2019
- Eitel, Elisabeth. (2014), Basic Rotary Encoder: Overview and New Technologies, <http://machinedesign.com/sensors/basics-rotary-encoders-overview-and-newtechnologies-0>
- Fahmizal, 2011, Permanent magnet dc motor, <http://fahmizaleeits.wordpress.com/2011/12/04/driver-motor-dc-padarobot-beroda-dengan-configuration-h-bridge-mosfet/> accessed on June 16 2019
- Hidayat, Anton. 2014. DC motor. Teaching Material for Robotics. Andalas University. Hidayat, Anton. 2014. DC motor. Teaching Material for Robotics. Andalas University.
- Haratul, Arma. 2018. Design and Build of Cakra Class Submarine Periscope Repeater Using Dot Matrix. Surabaya
- Ija Sembiring, 2009, Setting the speed of a dc motor, <http://repository.usu.ac.id/bitstream/123456789/11857/1/09E00078.pdf> accessed on June 24, 2010
- Mohammad Nasucha (2015), Development Of An Obstacle Avoiding Robot, Jaya Development University.
- Mech, Hades. (2010), Rotary Encoder, [http://hades.mech.northwestern.edu/index.php/Rotary\\_Encoder](http://hades.mech.northwestern.edu/index.php/Rotary_Encoder)
- Mechatronics crew. (2014), Introduction to Microcontrollers
- Widodo Budiharto 2015, Intelligent Surveillance Robots with Obstacle Avoidance Capabilities Using Neural Networks, School of Computer Science, Bina Nusantara University, Jakarta, Indonesia.